

MBRD1040

Rev.H Oct.-2024

描述 / Descriptions

TO-252 塑封封装 肖特基二极管。

TO-252 Plastic package Schottky diode.

特征 / Features

低正向压降，低功耗，效率高，无卤产品。

Low forward voltage drop, low power losses, High efficiency operation, HF Product.

用途 / Applications

用于高频、低压、大电流整流二极管，续流二极管，保护二极管。

For use in low voltage, high frequency inverters, free wheeling, and polarity protection applications.

内部等效电路 / Equivalent Circuit

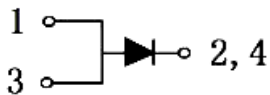

引脚排列 / Pinning

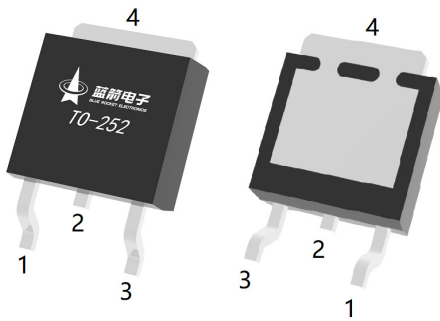

PIN1 : Anode

PIN 2,4 : Cathode

PIN 3 : Anode

印章代码 / Marking

见印章说明。

See Marking Instructions.

极限参数 / Absolute Maximum Ratings(Ta=25°C)

参数 Parameter	符号 Symbol	数值 Rating	单位 Unit
Peak Repetitive Reverse Voltage Working Peak Reverse Voltage DC Reverse Voltage	V_{RRM} V_{RWM} V_{DC}	40	V
RMS Reverse Voltage	V_{RMS}	31.5	V
Average forward rectified Current	$I_{F(AV)}$	1×10	A
Non Repetitive Peak Surge Current	I_{FSM}	100	A
Thermal Resistance Junction to Case	$R_{\theta Jc}$	2	°C/W
Junction and Storage Temperature Range	$T_j T_{stg}$	-55~+150	°C

电性能参数 / Electrical Characteristics(Ta=25°C)

参数 Parameter	符号 Symbol	测试条件 Test Conditions	最小值 Min	典型值 Typ	最大值 Max	单位 Unit
Reverse Voltage	$V_{(BR)R}$	$I_R = 1mA$ $T_a = 25^\circ C$	40			V
Peak Forward Voltage	V_{FM}	$I_F = 2.0A$ $T_a = 25^\circ C$		0.41	0.45	V
		$I_F = 2.0A$ $T_a = 125^\circ C$		0.22	0.28	V
		$I_F = 10A$ $T_a = 25^\circ C$		0.55	0.6	V
		$I_F = 10A$ $T_a = 125^\circ C$		0.37	0.45	V
Instantaneous Reverse Current	I_R (Note 1)	$V_R = 35V$ $T_a = 25^\circ C$		100	300	uA
		$V_R = 35V$ $T_a = 125^\circ C$		12.5	25	mA

注/Notes:

- 使用极短的测试时间,以尽量减少自热效应。/Short duration pulse test used to minimize self-heating effect.
- 除非特别注明,数值为一个芯片的参数。/ Unless otherwise noted, values for the parameters of a single chip

电参数曲线图 / Electrical Characteristic Curve

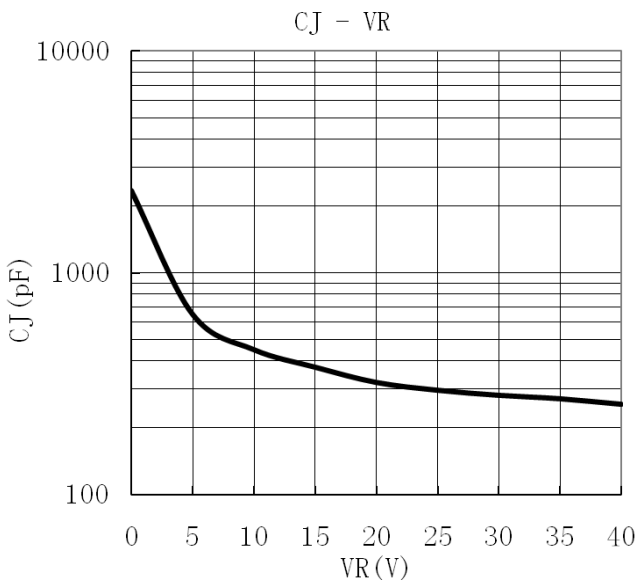
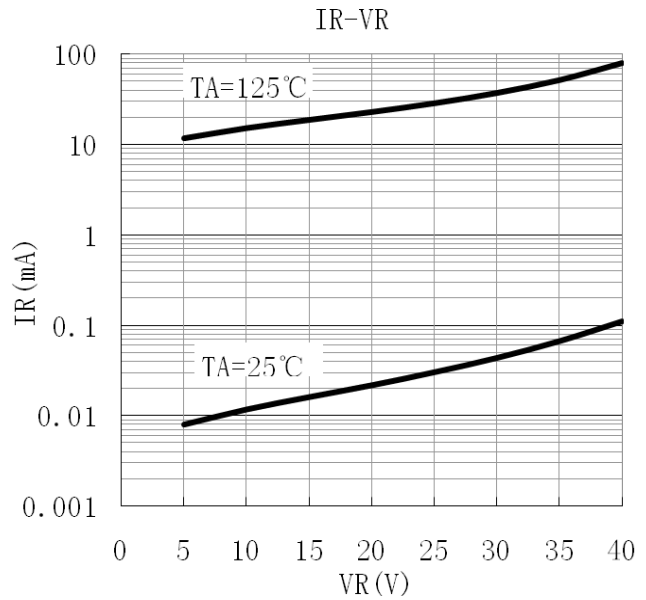
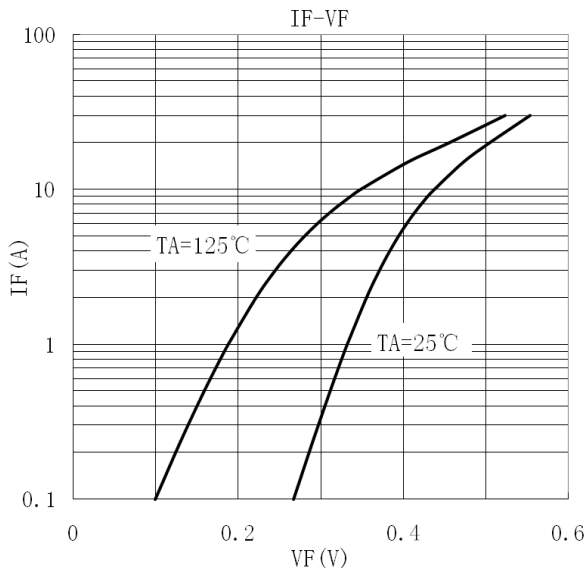
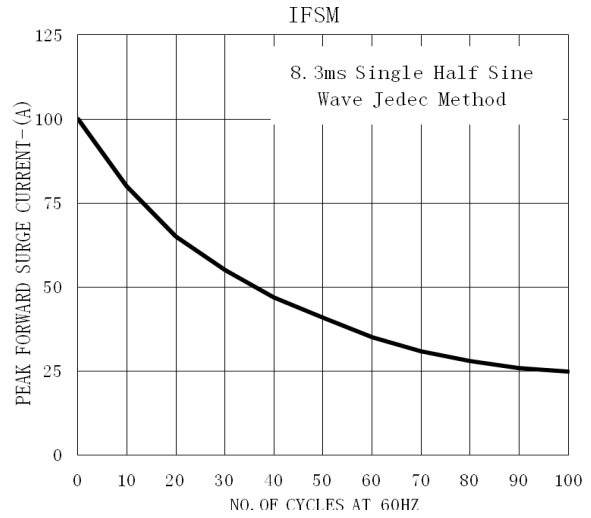
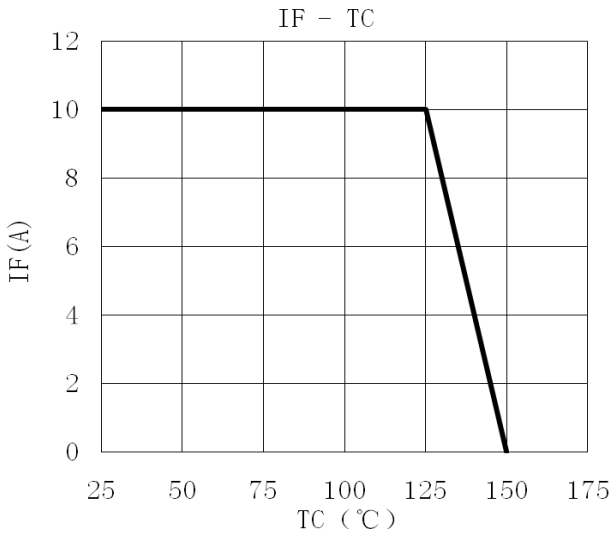

外形尺寸图 / Package Dimensions

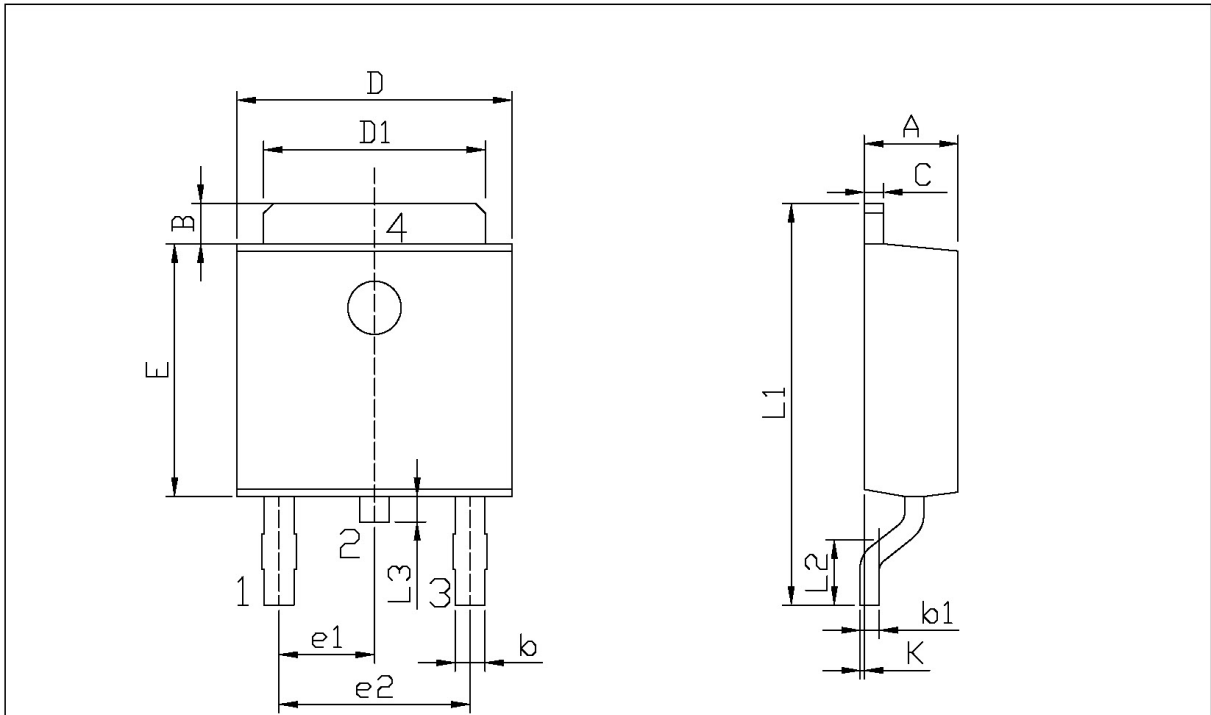

单位: mm

Symbol	Dimensions In Millimeters		Symbol	Dimensions In Millimeters	
	Min	Max		Min	Max
A	2.20	2.40	E	5.95	6.25
B	0.95	1.25	e1	2.24	2.34
b	0.50	0.90	e2	4.43	4.73
b1	0.45	0.55	L1	9.45	9.95
C	0.45	0.55	L2	1.25	1.75
D	6.45	6.75	L3	0.60	0.90
D1	5.10	5.50	K	0.00	0.10

TO-252

印章说明 / Marking Instructions

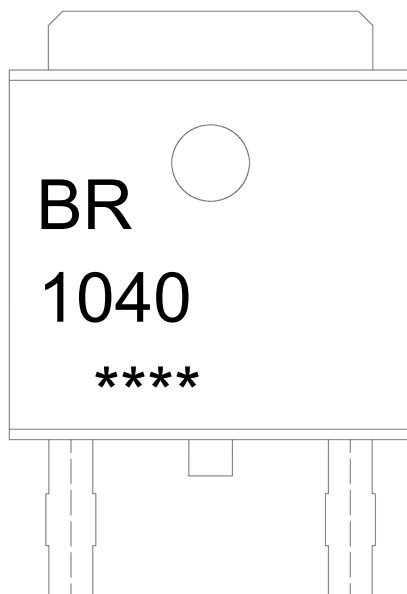

说明：

BR： 为公司代码

1040： 为型号代码

****： 为生产批号代码，随生产批号变化

Note:

BR: Company Code

1040: Product Type Code

****: Lot No. Code, code change with Lot No

回流焊温度曲线图(无铅) / Temperature Profile for IR Reflow Soldering(Pb-Free)

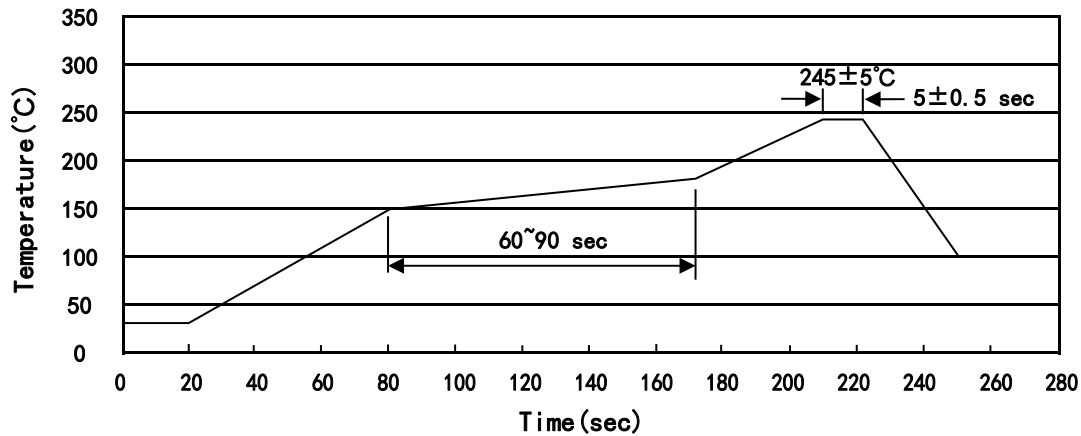

说明：

- 1、预热温度 150~180°C，时间 60~90sec;
- 2、峰值温度 245±5°C，时间持续为 5±0.5sec;
- 3、焊接制程冷却速度为 2~10°C/sec.

Note:

- 1.Preheating:150~180°C, Time:60~90sec.
- 2.Peak Temp.:245±5°C, Duration:5±0.5sec.
3. Cooling Speed: 2~10°C/sec.

耐焊接热试验条件 / Resistance to Soldering Heat Test Conditions

温度：260±5°C 时间：10±1 sec. Temp.:260±5°C Time:10±1 sec

包装规格 / Packaging SPEC.

卷盘包装 / REEL

Package Type 封装形式	Units 包装数量					Dimension 包装尺寸 (unit: mm ³)		
	Units/Reel 只/卷盘	Reels/Inner Box 卷盘/盒	Units/Inner Box 只/盒	Inner Boxes/Outer Box 盒/箱	Units/Outer Box 只/箱	Reel	Inner Box 盒	Outer Box 箱
TO-252	2,500	2	5,000	6	30,000	13" ×16	360×360×50	380×335×366

套管包装 / TUBE

Package Type 封装形式	Units 包装数量					Dimension 包装尺寸 (unit: mm ³)		
	Units/Tube 只/套管	Tubes/Inner Box 套管/盒	Units/Inner Box 只/盒	Inner Boxes/Outer Box 盒/箱	Units/Outer Box 只/箱	Tube 套管	Inner Box 盒	Outer Box 箱
TO-251/252	75	48	3,600	5	18,000	526×20.5×5.25	555×164×50	575×290×180

使用说明 / Notices