

描述 / Descriptions

TO-220FL 塑封封装 N 沟道 MOS 场效应管。N-CHANNEL MOSFET in a TO-220FL Plastic Package.

特征 / Features

低栅电荷,低反馈电容,开关速度快。

Low gate charge, low crss, fast switching.

用途 / Applications

用于高功率 DC/DC 转换和功率开关。

These devices are well suited for high efficiency switching DC/DC converters.

内部等效电路 / Equivalent Circuit

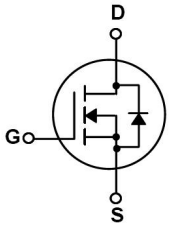

引脚排列 / Pinning

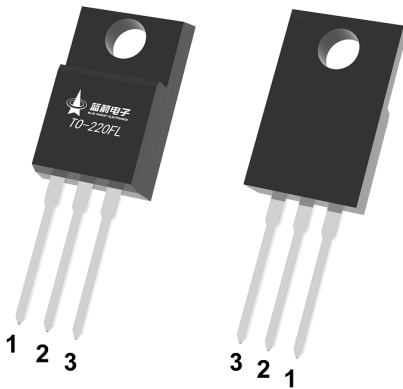

PIN1 : G

PIN 2 : D

PIN 3 : S

印章代码 / Marking

见印章说明。 See Marking Instructions.

极限参数 / Absolute Maximum Ratings(Ta=25°C)

参数 Parameter	符号 Symbol	数值 Rating	单位 Unit
Drain-Source Voltage	V _{DSS}	650	V
Drain Current	I _D (T _c =25°C)	10	A
Drain Current	I _D (T _c =100°C)	5.7	A
Drain Current - Pulsed	I _{DM}	38	A
Gate-Source Voltage	V _{GSS}	±30	V
Single Pulsed Avalanche Energy	E _{AS}	700	mJ
Repetitive Avalanche Energy	E _{AR}	15.6	mJ
Avalanche Current	I _{AR}	9.5	A
Thermal Resistance, Junction to Case	R _{θJC}	2.5	°C/W
Thermal Resistance, Junction to Ambient	R _{θJA}	62.5	°C/W
Power Dissipation	P _D (T _c =25°C)	50	W
Operating and Storage Temperature Range	T _J , T _{STG}	-55 to 150	°C

电性能参数 / Electrical Characteristics(Ta=25°C)

参数 Parameter	符号 Symbol	测试条件 Test Conditions	最小值 Min	典型值 Typ	最大值 Max	单位 Unit
Drain-Source Breakdown Voltage	BV _{DSS}	V _{GS} =0V I _D =250μA	650			V
Zero Gate Voltage Drain Current	I _{DSS}	V _{DS} =600V V _{GS} =0V			1.0	μA
		V _{DS} =480V T _c =125°C			10	μA
Gate-Body Leakage Current Forward	I _{GSS}	V _{GS} =±30V V _{DS} =0V			±10	μA
Gate Threshold Voltage	V _{GS(th)}	V _{DS} =V _{GS} I _D =250μA	2.0		4.0	V
Static Drain-Source On-Resistance	R _{DS(on)}	V _{GS} =10V I _D =4.75A		0.8	0.95	Ω
Forward Transconductance	g _{FS}	V _{DS} =40V I _D =4.75A		8.0		S
Drain-Source Diode Forward Voltage	V _{SD}	V _{GS} =0V I _S =9.5A			1.4	V
Input Capacitance	C _{iss}	V _{DS} =25V V _{GS} =0V f=1.0MHz		1570	2040	pF
Output Capacitance	C _{oss}			166	215	pF
Reverse Transfer Capacitance	C _{rss}			18	24	pF
Turn-On Delay Time	t _{d(on)}	V _{DD} =300V I _D =9.5A R _G =25Ω		23	55	ns
Turn-On Rise Time	t _r			69	150	ns
Turn-Off Delay Time	t _{d(off)}			144	300	ns
Turn-Off Fall Time	t _f			77	165	ns

电参数曲线图 / Electrical Characteristic Curve

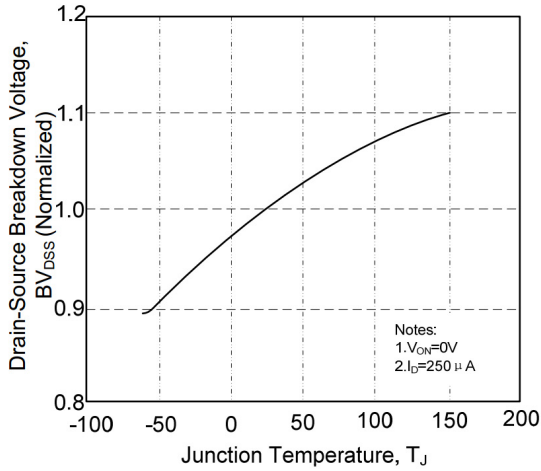

1. Breakdown Voltage Variation vs. Temperature

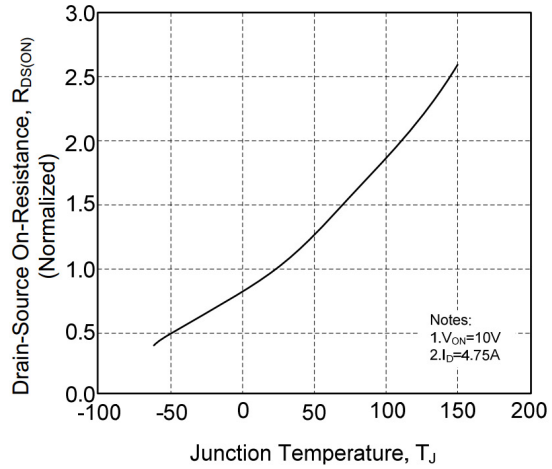

2. On-Resistance Variation vs. Temperature

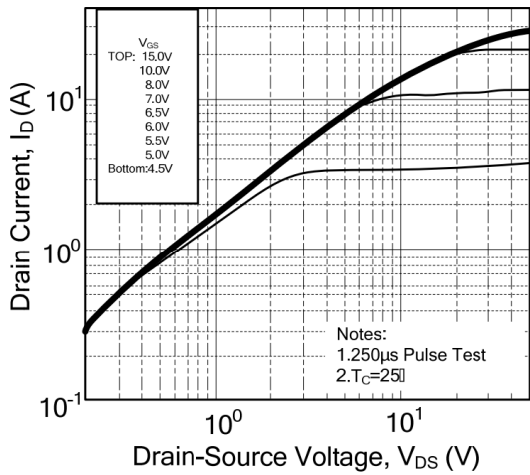

3. On-Region Characteristics

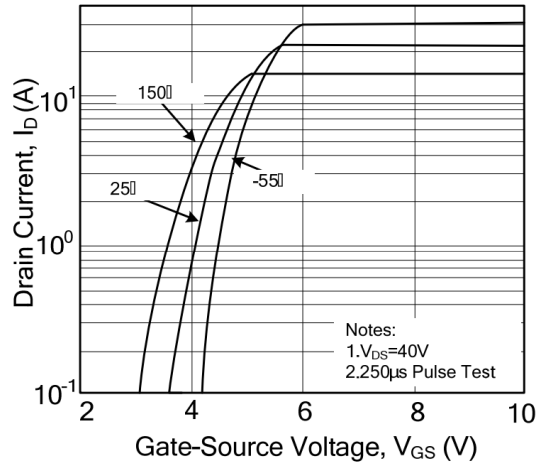

4. Transfer Characteristics

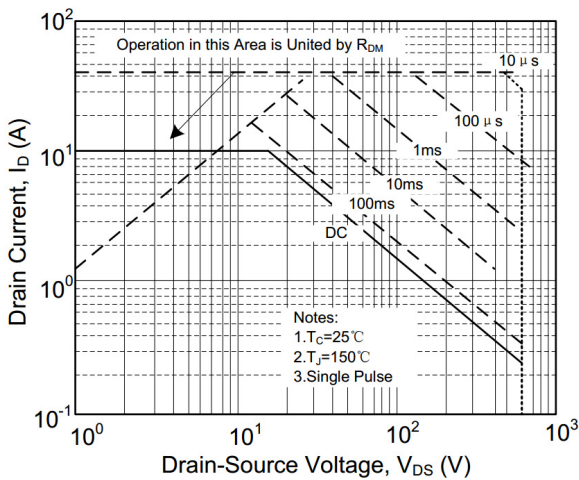

5. Maximum Safe Operating Area

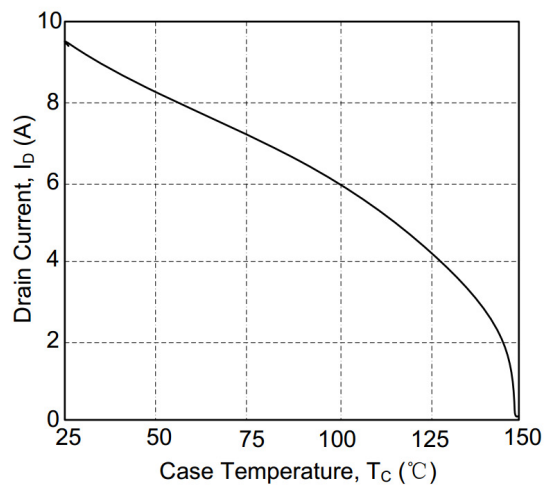

6. Maximum Drain Current vs. Case Temperature

外形尺寸图 / Package Dimensions

TO-220FL

单位: mm

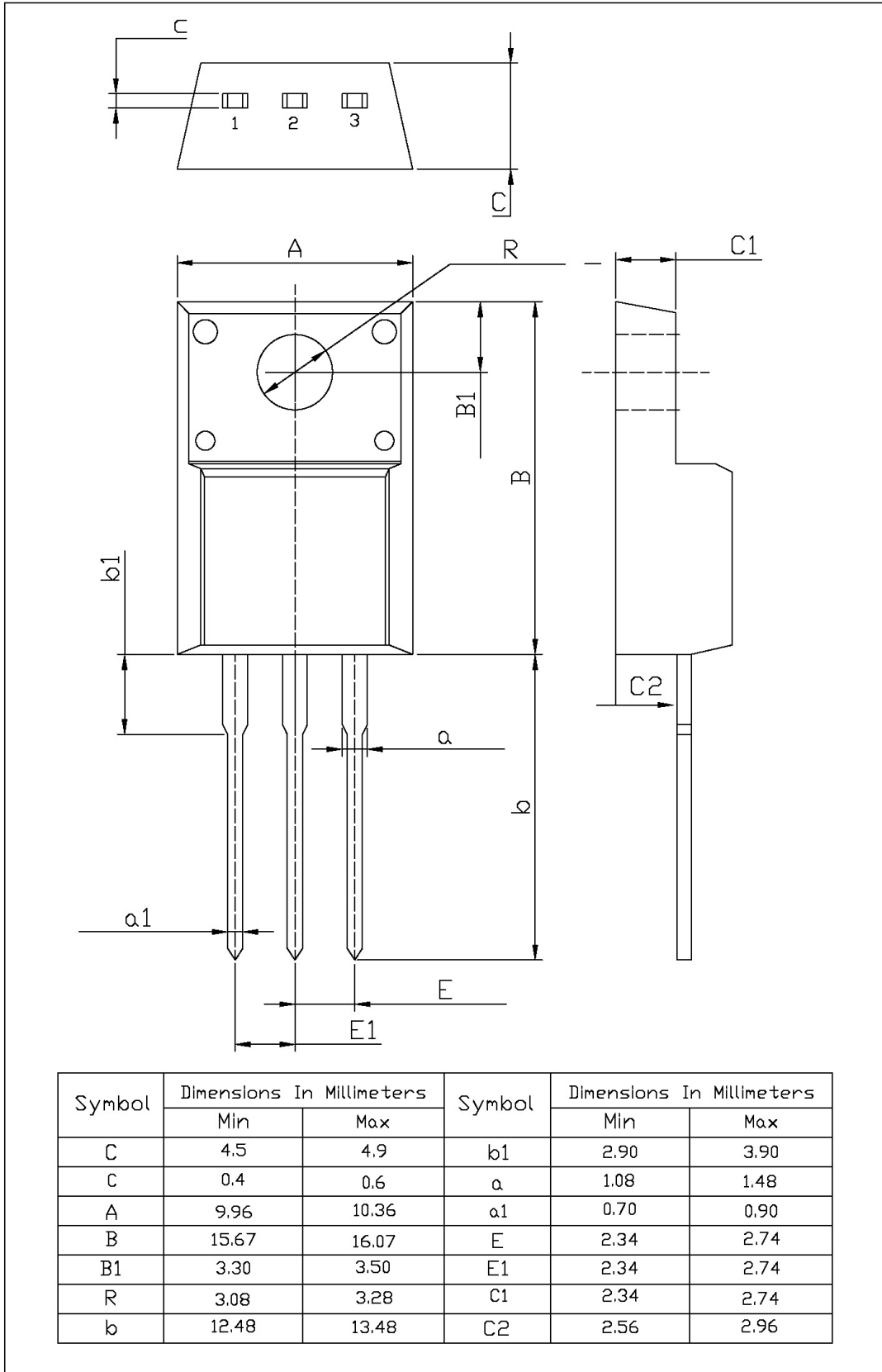

印章说明 / Marking Instructions

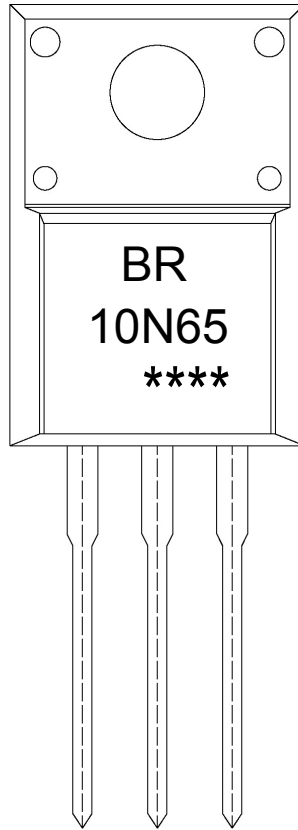

说明：

BR： 为公司代码

10N65： 为型号代码

****： 为生产批号代码，随生产批号变化

Note:

BR: Company Code

10N65: Product Type

****: Lot No. Code, code change with Lot No

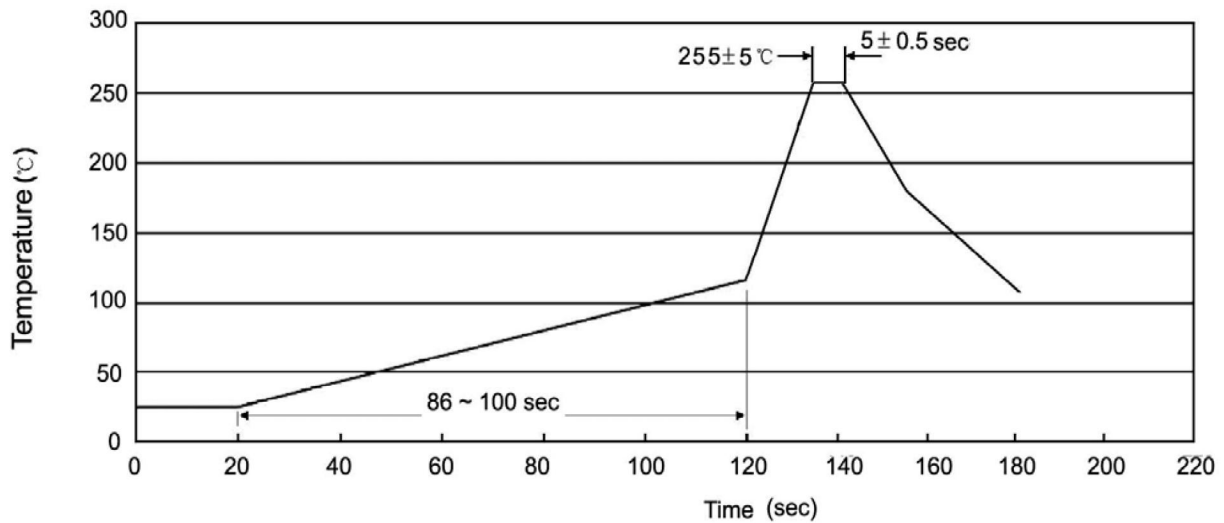
波峰焊温度曲线图(无铅) / Temperature Profile for Dip Soldering(Pb-Free)

说明：

- 1、预热温度 25 ~ 150°C，时间 60 ~ 90sec;
- 2、峰值温度 255±5°C，时间持续为 5±0.5sec;
- 3、焊接制程冷却速度为 2 ~ 10°C/sec.

Note:

- 1.Preheating:25~150°C, Time:60~90sec.
- 2.Peak Temp.:255±5°C, Duration:5±0.5sec.
3. Cooling Speed: 2~10°C/sec.

耐焊接热试验条件 / Resistance to Soldering Heat Test Conditions

温度：270±5°C

时间：10±1 sec.

Temp.:270±5°C

Time:10±1 sec

包装规格 / Packaging SPEC.

套管包装 / TUBE

Package Type 封装形式	Units 包装数量					Dimension 包装尺寸 (unit: mm ³)		
	Units/Tube 只/套管	Tubes/Inner Box 套管/盒	Units/Inner Box 只/盒	Inner Boxes/Outer Box 盒/箱	Units/Outer Box 只/箱	Tube 套管	Inner Box 盒	Outer Box 箱
TO-220FL	50	20	1,000	5	5,000	532×33×7.0	555×164×50	575×290×180

使用说明 / Notices