

BRC5700P10DPQ

Rev.A Dec.-2023

描述 / Descriptions

TO-252 塑封封装 P 沟道 MOS 场效应管。
P-CHANNEL MOSFET in a TO-252 Plastic Package.

特征 / Features

$V_{DS}(V)=-100V$ $I_D=-22A$

$R_{DS(ON)}@-10V<70m\Omega$ (Typ.67mR)

$R_{DS(ON)}@-4.5V<85m\Omega$ (Typ.70mR)

符合 AEC-Q101 标准高可靠性要求，无卤产品。Qualified to AEC-Q101 Standards for High Reliability, HF Product.

用途 / Applications

工业级DC/DC转换器的电源管理，满足汽车应用的严格要求。

Power Management of Industrial DC/DC Converter, Meet the stringent requirements of automotive applications.

内部等效电路 / Equivalent Circuit

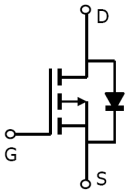

引脚排列 / Pinning

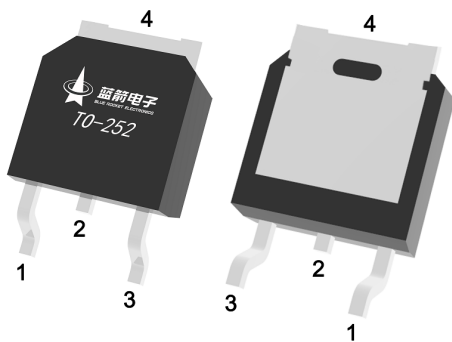

PIN 1 : G

PIN 2 : D

PIN 3 : S

PIN 4 : D

印章代码 / Marking

见印章说明。

See Marking Instructions.

极限参数 / Absolute Maximum Ratings(T_a=25°C)

参数 Parameter	符号 Symbol	数值 Rating	单位 Unit
Drain-Source Voltage	V _{DS}	-100	V
Drain Current - Continuous	I _D (T _c =25°C)	-22	A
Drain Current – Pulsed	I _{DM}	-66	A
Gate-Source Voltage	V _{GS}	±20	V
Power Dissipation	P _D (T _c =25°C)	75	W
Single Pulse Avalanche Energy(L=0.5mH)	E _{AS}	176.4	mJ
Avalanche Current(L=0.5mH)	I _{AS}	-21	A
Junction and Storage Temperature Range	T _j , T _{stg}	-55 to 150	°C
Thermal resistance, junction - ambient	Steady-State R _{θJA}	62	°C/W
Thermal resistance, junction - case	Steady-State R _{θJC}	1.67	

电性能参数 / Electrical Characteristics(T_a=25°C)

参数 Parameter	符号 Symbol	测试条件 Test Conditions	最小值 Min	典型值 Typ	最大值 Max	单位 Unit
Drain-Source Breakdown Voltage	BV _{DSS}	I _D =-250μA V _{GS} =0V	-100	-113		V
Zero Gate Voltage Drain Current	I _{DSS}	V _{DS} =-100V V _{GS} =0V			-1	uA
Gate-Body leakage current	I _{GSS}	V _{DS} =0V, V _{GS} =±20V			±100	nA
Gate Threshold Voltage	V _{GS(th)}	V _{DS} =V _{GS} I _D =-250μA	-1	-2.0	-2.5	V
Static Drain-Source On-Resistance	R _{DS(ON)}	V _{GS} =-10V, I _D =-10A		67	70	mΩ
		V _{GS} =-4.5V, I _D =-6A		70	85	
Diode Forward Voltage	V _{SD}	I _S =-1A, V _{GS} =0V			-1.2	V
Input Capacitance	C _{iss}	V _{DS} =-15V V _{GS} =0V f=1.0MHz		2820		pF
Output Capacitance	C _{oss}			840		
Reverse Transfer Capacitance	C _{rss}			670		
Gate resistance	R _g	V _{GS} =0V V _{DS} =0V f=1MHz		2.7		Ω
Total Gate Charge	Q _{g(10V)}	V _{GS} =-10V, V _{DS} =-50V, I _D =-5A		5.9		nC
Total Gate Charge	Q _{g(4.5V)}			2.7		
Gate Source Charge	Q _{gs}			1.2		
Gate Drain Charge	Q _{gd}			1.2		

电性能参数 / Electrical Characteristics(Ta=25°C)

参数 Parameter	符号 Symbol	测试条件 Test Conditions	最小值 Min	典型值 Typ	最大值 Max	单位 Unit
Turn-On Delay Time	$t_{d(on)}$	$V_{GS}=-10V$ $V_{DS}=-50V$ $R_L=10\ \Omega$ $R_{GEN}=3\ \Omega$		6		ns
Turn-On Rise Time	t_r			2.4		
Turn-Off Delay Time	$t_{d(off)}$			19		
Turn-Off Fall Time	t_f			2.6		

电参数曲线图 / Electrical Characteristic Curve

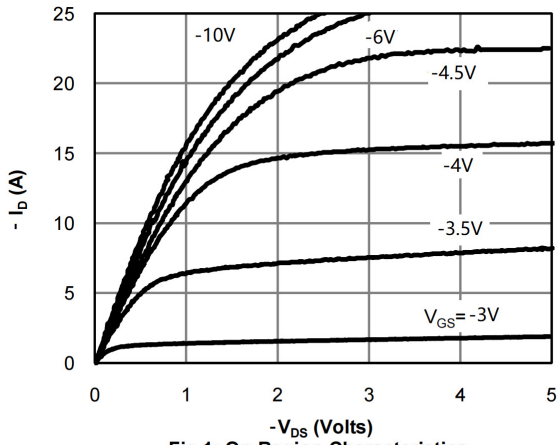

Fig 1: On-Region Characteristics

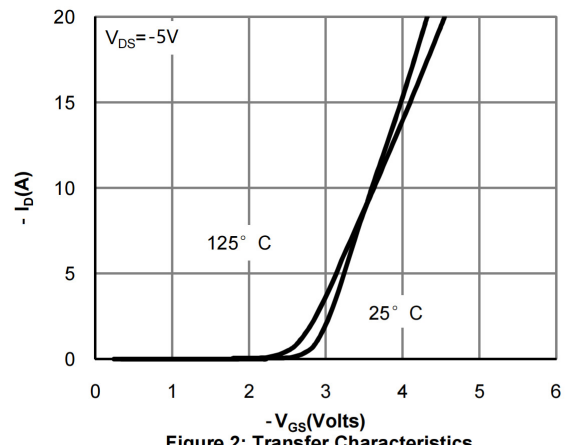

Figure 2: Transfer Characteristics

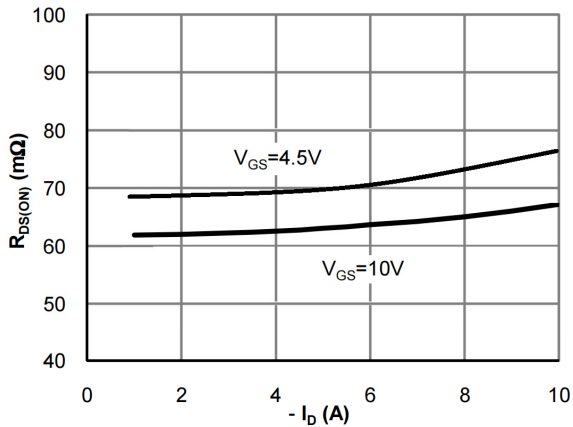

Figure 3: On-Resistance vs. Drain Current and Gate Voltage

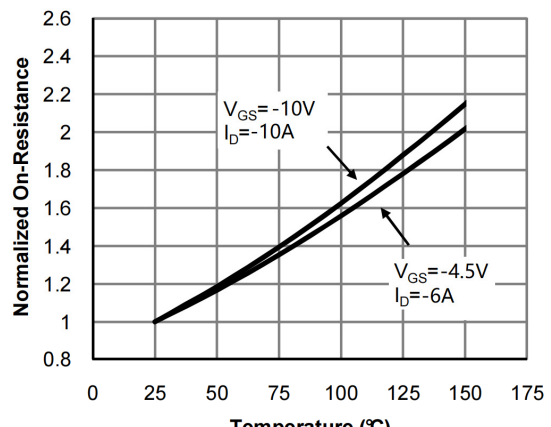

Figure 4: On-Resistance vs. Junction Temperature

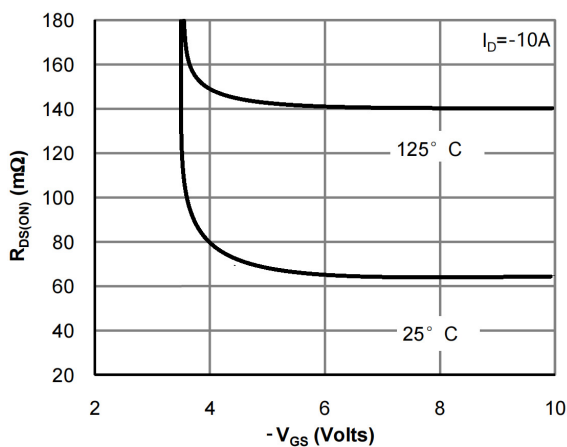

Figure 5: On-Resistance vs. Gate-Source Voltage

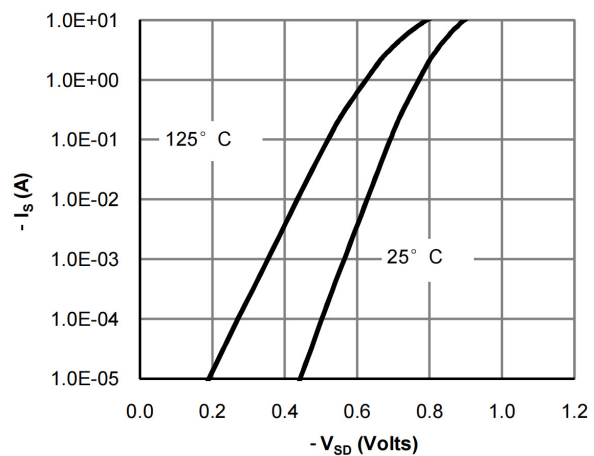

Figure 6: Body-Diode Characteristics

电参数曲线图 / Electrical Characteristic Curve

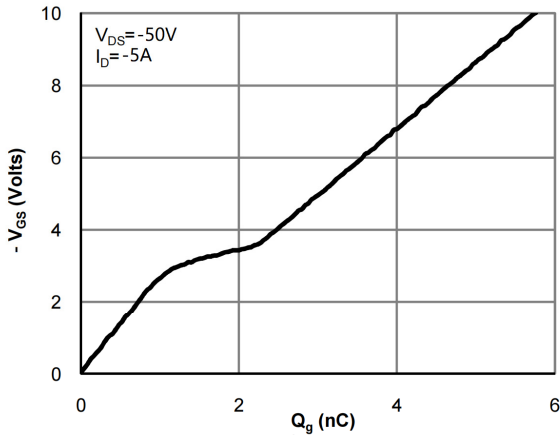

Figure 7: Gate-Charge Characteristics

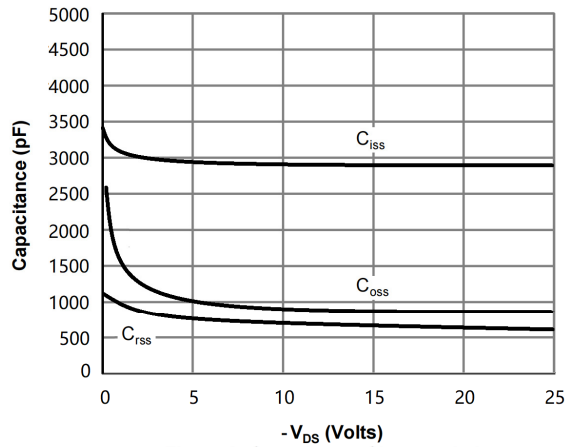

Figure 8: Capacitance Characteristics

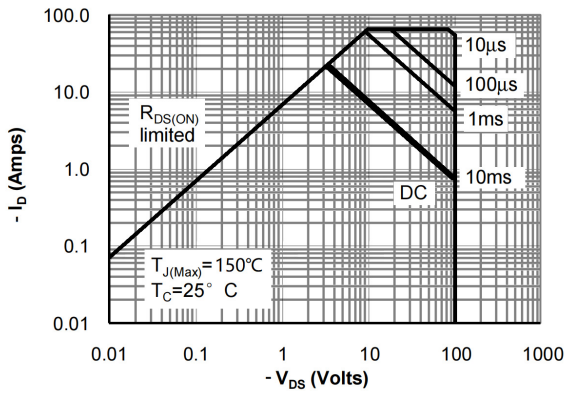

Figure 9: Maximum Forward Biased Safe Operating Area

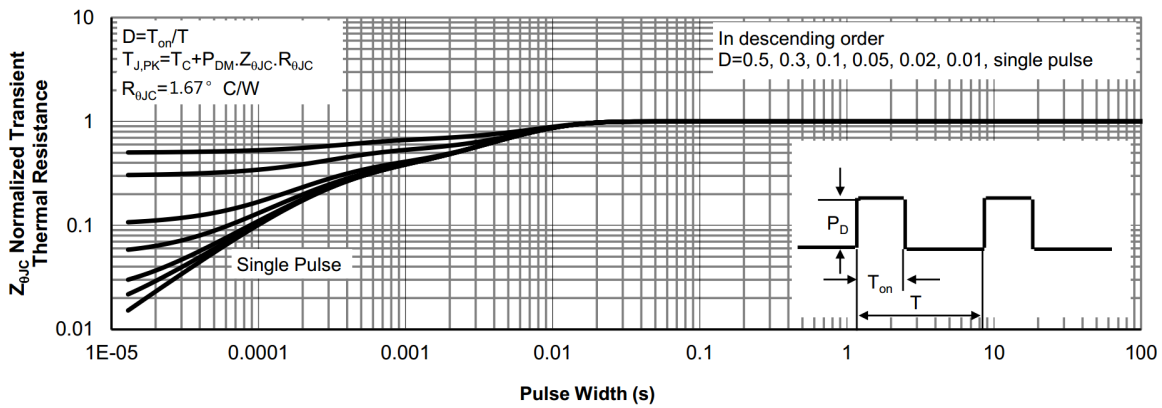
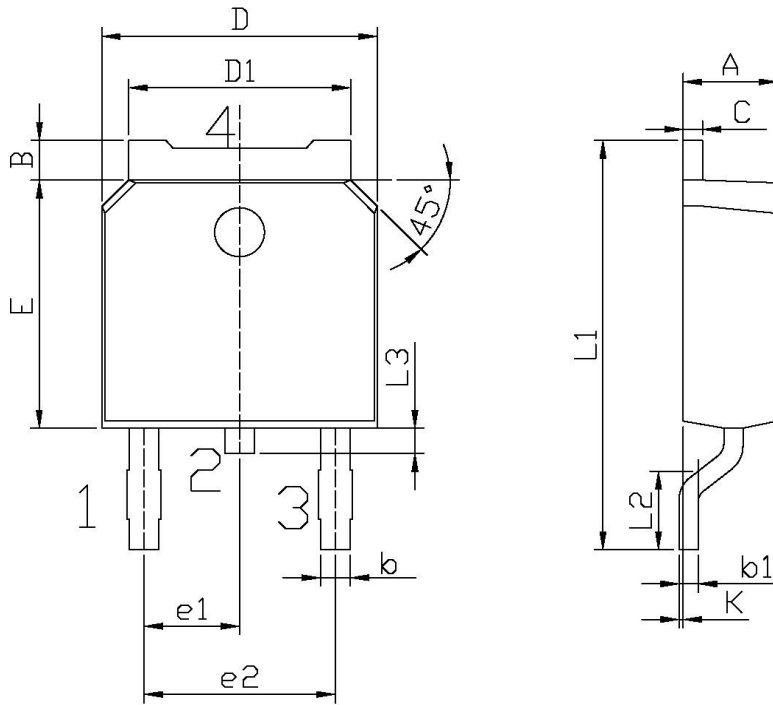

Figure 10: Normalized Maximum Transient Thermal Impedance

外形尺寸图 / Package Dimensions



单位: mm

Symbol	Dimensions In Millimeters		Symbol	Dimensions In Millimeters	
	Min	Max		Min	Max
A	2.20	2.40	E	5.95	6.25
B	0.95	1.25	e1	2.24	2.34
b	0.70	0.90	e2	4.43	4.73
b1	0.45	0.55	L1	9.85	10.35
C	0.45	0.55	L2	1.70	2.00
D	6.45	6.75	L3	0.60	0.90
D1	5.10	5.50	K	0.00	0.10

TO-252

印章说明 / Marking Instructions

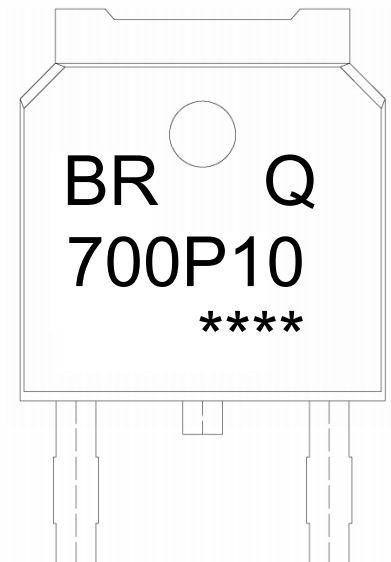

说明：

BR： 为公司代码

Q： 为汽车无卤产品标识

700P10： 为型号代码

****： 为生产批号代码，随生产批号变化

Note:

BR: Company Code

Q: Automobile halogen-free product Code

700P10: Product Type Code

****: Lot No. Code, code change with Lot No

回流焊温度曲线图(无铅) / Temperature Profile for IR Reflow Soldering(Pb-Free)

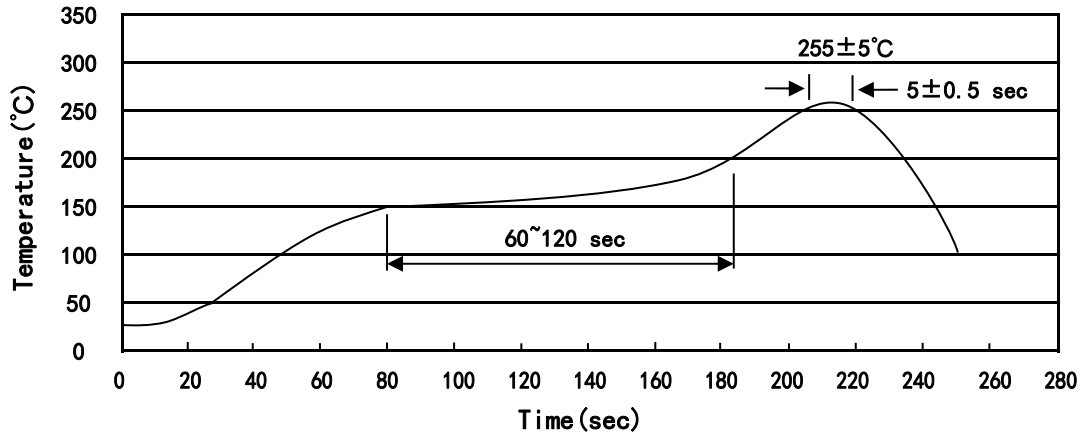

说明：

- 1、预热温度 150~200°C，时间 60~120sec;
- 2、峰值温度 255±5°C，时间持续为 5±0.5sec;
- 3、焊接制程冷却速度为 2~10°C/sec.

Note:

- 1.Preheating:150~200°C, Time:60~120sec.
- 2.Peak Temp.:255±5°C, Duration:5±0.5sec.
3. Cooling Speed: 2~10°C/sec.

耐焊接热试验条件 / Resistance to Soldering Heat Test Conditions

温度：260±5°C

时间：10±1 sec.

Temp.:260±5°C

Time:10±1 sec

包装规格 / Packaging SPEC.

卷盘包装 / REEL

Package Type 封装形式	Units 包装数量					Dimension 包装尺寸 (unit: mm ³)		
	Units/Reel 只/卷盘	Reels/Inner Box 卷盘/盒	Units/Inner Box 只/盒	Inner Boxes/Outer Box 盒/箱	Units/Outer Box 只/箱	Reel	Inner Box 盒	Outer Box 箱
TO-252	2,500	2	5,000	6	30,000	13" ×16	360×360×50	380×335×366

套管包装 / TUBE

Package Type 封装形式	Units 包装数量					Dimension 包装尺寸 (unit: mm ³)		
	Units/Tube 只/套管	Tubes/Inner Box 套管/盒	Units/Inner Box 只/盒	Inner Boxes/Outer Box 盒/箱	Units/Outer Box 只/箱	Tube 套管	Inner Box 盒	Outer Box 箱
TO-251/252	75	48	3,600	5	18,000	526×20.5×5.25	555×164×50	575×290×180

使用说明 / Notices