

# BRCS20N06DP

Rev.C Jun.-2023

DATA SHEET

## 描述 / Descriptions

TO-252 塑封封装 N 沟道 MOS 场效应管。  
 N-CHANNEL MOSFET in a TO-252 Plastic Package.

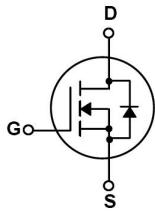
## 特征 / Features

$V_{DS}=60V$  ;  $I_D=20A$   
 $R_{DS(on)}@10V \leq 37m\Omega$  (Type.25m $\Omega$ )  
 $R_{DS(on)}@4.5V \leq 42m\Omega$  (Type.30m $\Omega$ )  
 无卤产品。 HF Product.

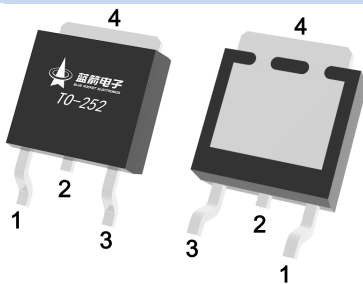
## 用途 / Applications

用于消费电子、电信、工业电源和 LED 背光的升压转换器和同步整流器。  
 Boost converters and synchronous rectifiers for consumer, telecom, industrial power supplies and LED backlighting.

## 内部等效电路 / Equivalent Circuit



## 引脚排列 / Pinning



PIN 1 : G      PIN 2 : D      PIN 3 : S      PIN 4 : D

## 印章代码 / Marking

见印章说明。 See Marking Instructions.

**极限参数 / Absolute Maximum Ratings(Ta=25°C)**

参数 Parameter	符号 Symbol	数值 Rating	单位 Unit
Drain-Source Voltage	V <sub>DSS</sub>	60	V
Drain Current	I <sub>D</sub> (Tc=25°C)	20	A
Drain Current - Pulsed	I <sub>DM</sub>	47	A
Gate-Source Voltage	V <sub>GS</sub>	±20	V
Avalanche energy(L=0.5mH)	E <sub>AS</sub>	58	mJ
Avalanche Current(L=0.5mH)	I <sub>AS</sub>	13	A
Power Dissipation	P <sub>D</sub> (Tc=25°C)	33.6	W
Operating and Storage Temperature Range	T <sub>J</sub> , T <sub>STG</sub>	-55 to 150	°C
Thermal Resistance, Junction to Ambient	R <sub>θJA</sub>	65	°C/W
Thermal Resistance, Junction to Case	R <sub>θJC</sub>	3.7	°C/W

**电性能参数 / Electrical Characteristics(Ta=25°C)**

参数 Parameter	符号 Symbol	测试条件 Test Conditions	最小值 Min	典型值 Typ	最大值 Max	单位 Unit
Drain-Source Breakdown Voltage	BV <sub>DSS</sub>	V <sub>GS</sub> =0V I <sub>D</sub> =250μA	60			V
Zero Gate Voltage Drain Current	I <sub>DSS</sub>	V <sub>DS</sub> =60V V <sub>GS</sub> =0V			1	μA
Gate-Body Leakage Current Forward	I <sub>GSS</sub>	V <sub>GS</sub> =±20V V <sub>DS</sub> =0V			±100	nA
Gate Threshold Voltage	V <sub>GS(th)</sub>	V <sub>DS</sub> =V <sub>GS</sub> I <sub>D</sub> =250μA	1.0	1.8	3.0	V
Static Drain-Source On-Resistance	R <sub>Ds(on)</sub>	V <sub>GS</sub> =10V I <sub>D</sub> =6A		25	37	mΩ
		V <sub>GS</sub> =4.5V I <sub>D</sub> =4A		30	42	mΩ
Drain-Source Diode Forward Voltage	V <sub>SD</sub>	V <sub>GS</sub> =0V I <sub>S</sub> =1A			1.2	V
Input Capacitance	C <sub>iss</sub>	V <sub>DS</sub> =25V V <sub>GS</sub> =0V f=1.0MHz		1060		pF
Output Capacitance	C <sub>oss</sub>			315		pF
Reverse Transfer Capacitance	C <sub>rss</sub>			65		pF
Total Gate Charge	Q <sub>g(10V)</sub>	V <sub>GS</sub> =10V V <sub>DS</sub> =30V I <sub>D</sub> =12A		7.5		nC
Total Gate Charge	Q <sub>g(4.5V)</sub>			3.8		
Gate Source Charge	Q <sub>gs</sub>			1.2		
Gate Drain Charge	Q <sub>gd</sub>			1.9		

## 电性能参数 / Electrical Characteristics(Ta=25°C)

参数 Parameter	符号 Symbol	测试条件 Test Conditions	最小值 Min	典型值 Typ	最大值 Max	单位 Unit
Turn-On Delay Time	$t_{d(on)}$	$V_{GS}=10V$ $V_{DS}=30V$ $R_L=2.5\Omega$ $R_{GEN}=3.0\Omega$		4.2		ns
Turn-On Rise Time	$t_r$			3.4		
Turn-Off Delay Time	$t_{d(off)}$			16		
Turn-Off Fall Time	$t_f$			2		

电参数曲线图 / Electrical Characteristic Curve

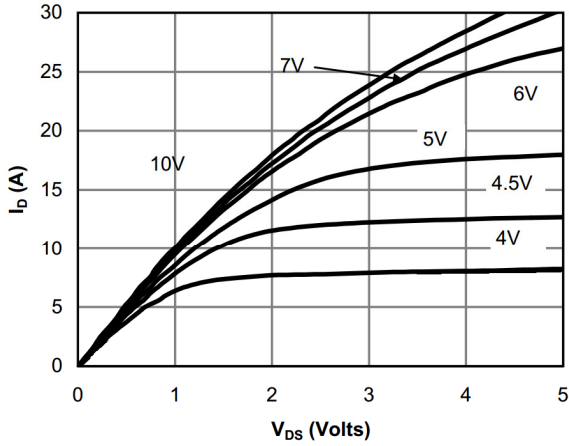


Fig 1: On-Region Characteristics

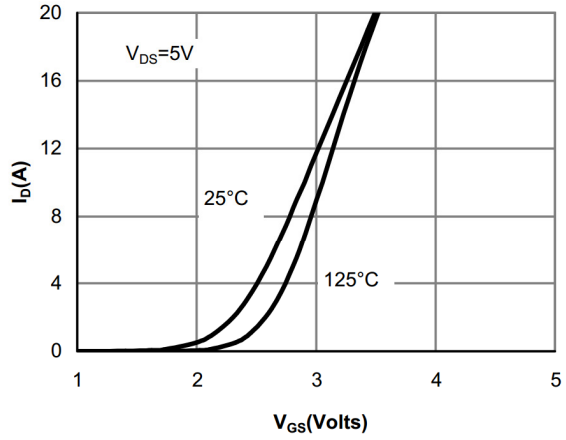


Figure 2: Transfer Characteristics

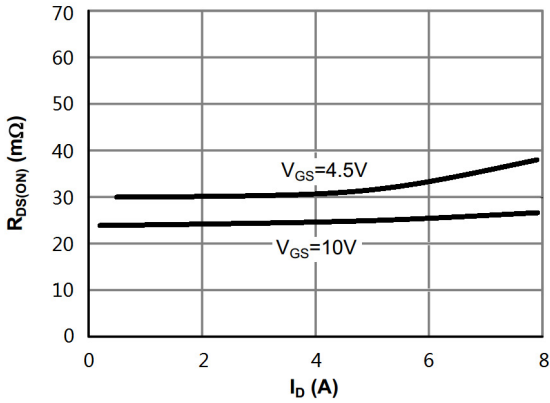


Figure 3: On-Resistance vs. Drain Current and Gate Voltage

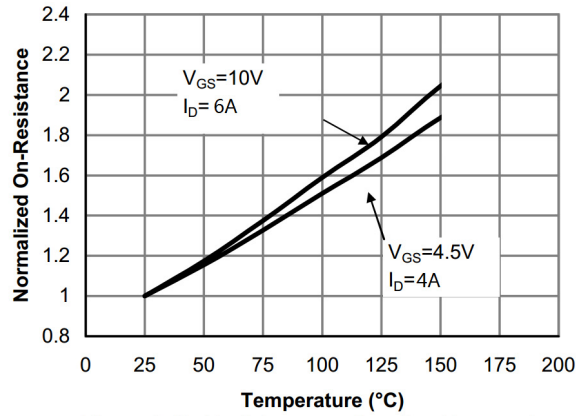


Figure 4: On-Resistance vs. Junction Temperature

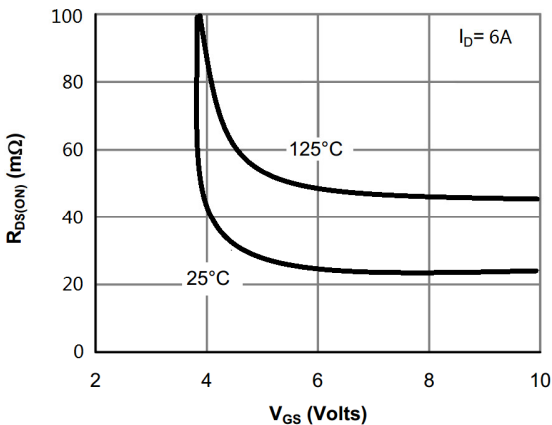


Figure 5: On-Resistance vs. Gate-Source Voltage

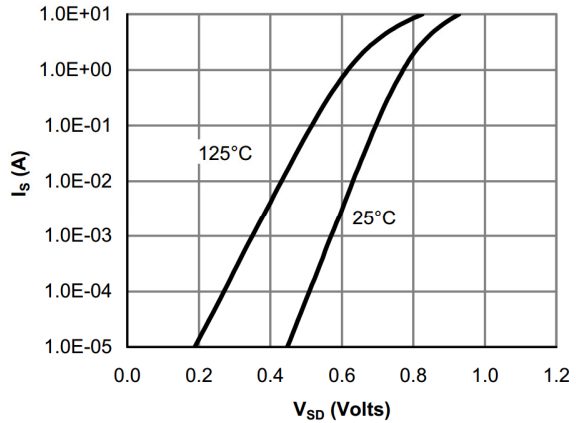
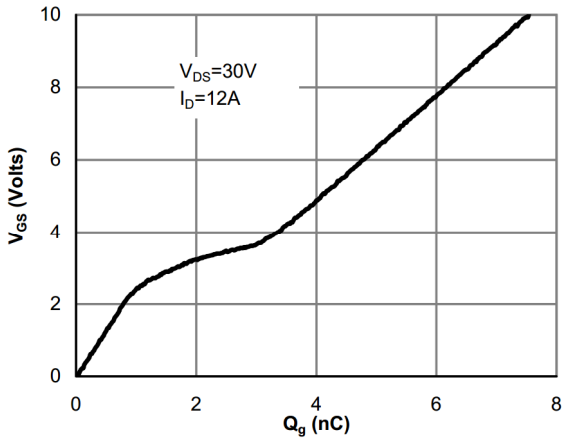
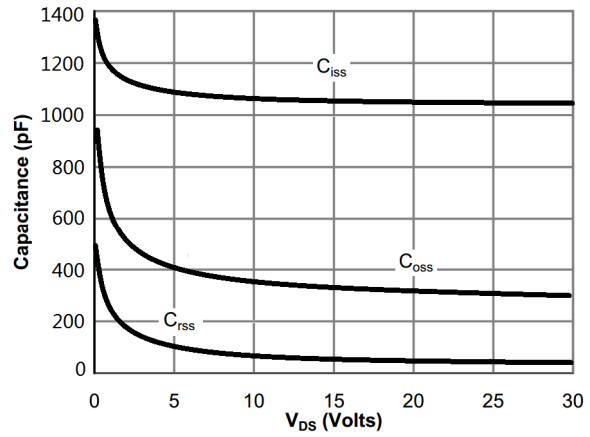


Figure 6: Body-Diode Characteristics

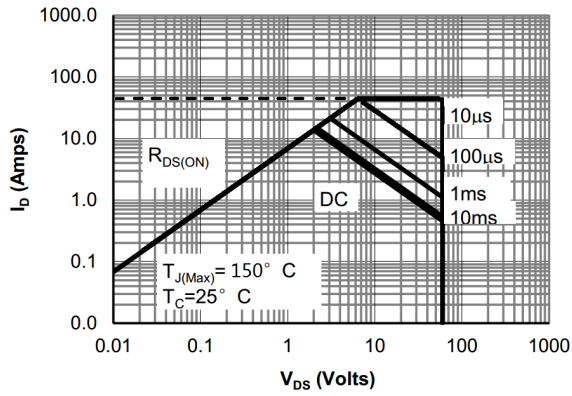
**电参数曲线图 / Electrical Characteristic Curve**



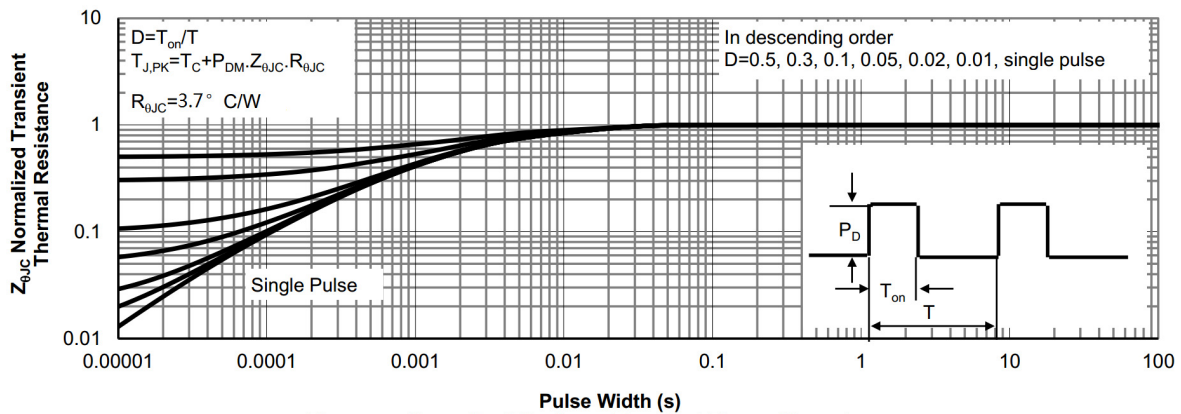
**Figure 7: Gate-Charge Characteristics**



**Figure 8: Capacitance Characteristics**

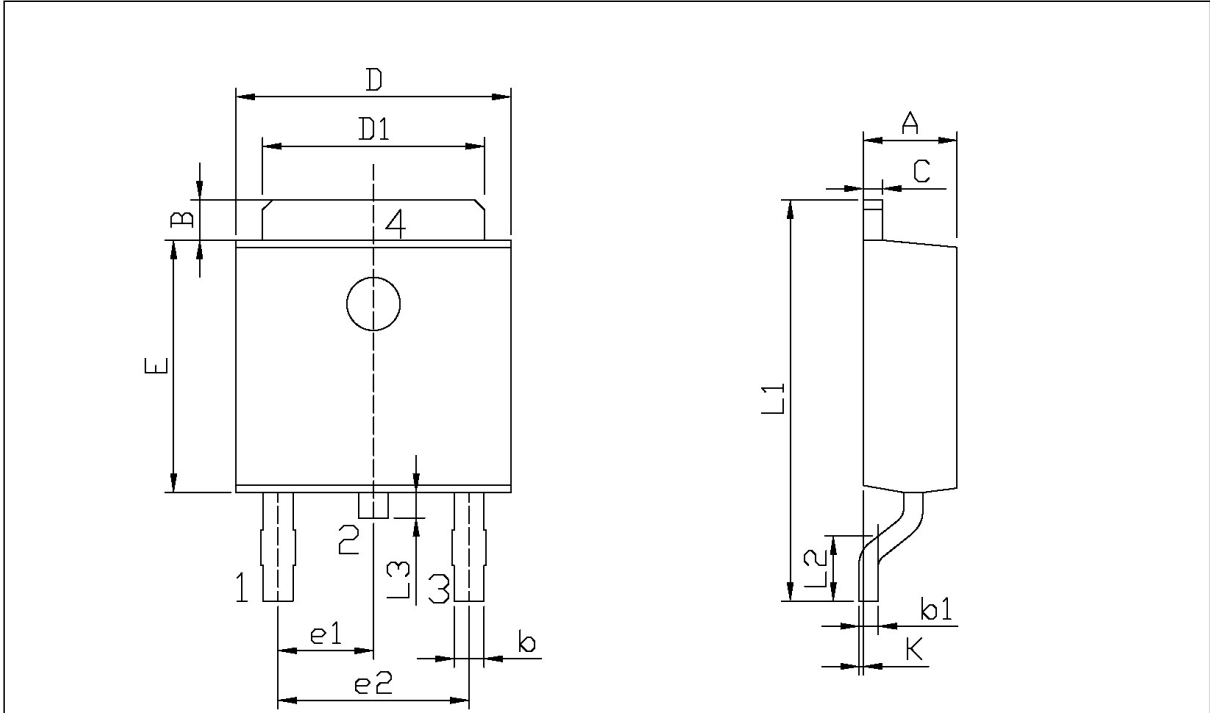


**Figure 9: Maximum Forward Biased Safe Operating Area**



**Figure 10: Normalized Maximum Transient Thermal Impedance**

**外形尺寸图 / Package Dimensions**

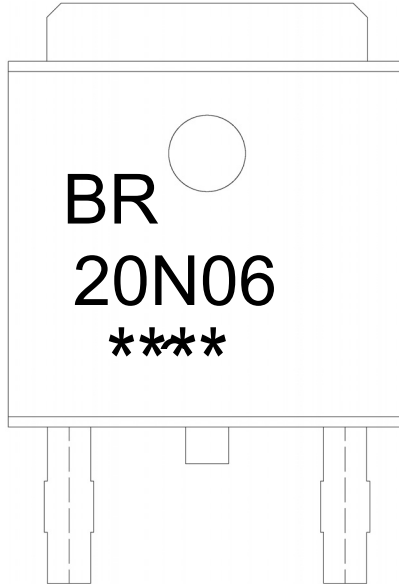


单位: mm

Symbol	Dimensions In Millimeters		Symbol	Dimensions In Millimeters	
	Min	Max		Min	Max
A	2.20	2.40	E	5.95	6.25
B	0.95	1.25	e1	2.24	2.34
b	0.50	0.90	e2	4.43	4.73
b1	0.45	0.55	L1	9.45	9.95
C	0.45	0.55	L2	1.25	1.75
D	6.45	6.75	L3	0.60	0.90
D1	5.10	5.50	K	0.00	0.10

TO-252

**印章说明 / Marking Instructions**



说明：

BR： 为公司代码

20N06： 为型号代码

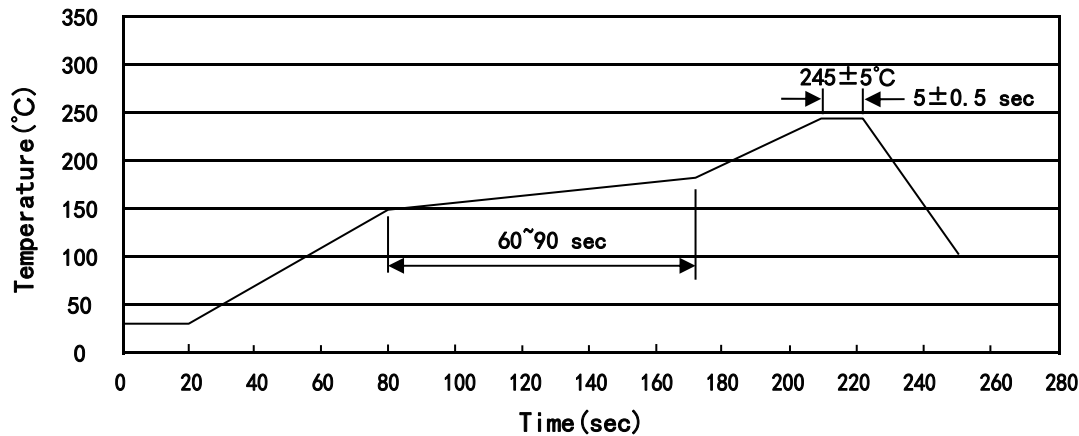
\*\*\*\*： 为生产批号代码，随生产批号变化

Note:

BR: Company Code

20N06: Product Type

\*\*\*\*: Lot No. Code, code change with Lot No

**回流焊温度曲线图(无铅) / Temperature Profile for IR Reflow Soldering(Pb-Free)**


说明：

- 1、预热温度 150~180°C，时间 60~90sec;
- 2、峰值温度 245±5°C，时间持续为 5±0.5sec;
- 3、焊接制程冷却速度为 2~10°C/sec.

Note:

- 1.Preheating:150~180°C, Time:60~90sec.
- 2.Peak Temp.:245±5°C, Duration:5±0.5sec.
3. Cooling Speed: 2~10°C/sec.

**耐焊接热试验条件 / Resistance to Soldering Heat Test Conditions**

温度：260±5°C

时间：10±1 sec.

Temp.:260±5°C

Time:10±1 sec

**包装规格 / Packaging SPEC.**

卷盘包装 / REEL

Package Type 封装形式	Units 包装数量					Dimension 包装尺寸 (unit: mm <sup>3</sup> )		
	Units/Reel 只/卷盘	Reels/Inner Box 卷盘/盒	Units/Inner Box 只/盒	Inner Boxes/Outer Box 盒/箱	Units/Outer Box 只/箱	Reel	Inner Box 盒	Outer Box 箱
TO-252	2,500	2	5,000	6	30,000	13" ×16	360×360×50	380×335×366

套管包装 / TUBE

Package Type 封装形式	Units 包装数量					Dimension 包装尺寸 (unit: mm <sup>3</sup> )		
	Units/Tube 只/套管	Tubes/Inner Box 套管/盒	Units/Inner Box 只/盒	Inner Boxes/Outer Box 盒/箱	Units/Outer Box 只/箱	Tube 套管	Inner Box 盒	Outer Box 箱
TO-251/252	75	48	3,600	5	18,000	526×20.5×5.25	555×164×50	575×290×180

**使用说明 / Notices**